

Our associates will ensure the tool works properly before you leave the store. If you experience issues with the tool while completing your project, simply bring it back to the Tool Rental Center to get a replacement. If you purchase Damage Protection at the time of your rental, you are not responsible for repair costs for tools that break due to normal use.





TE 2000-AVR (01)

English	1
Français	9
Español	19
Português	28

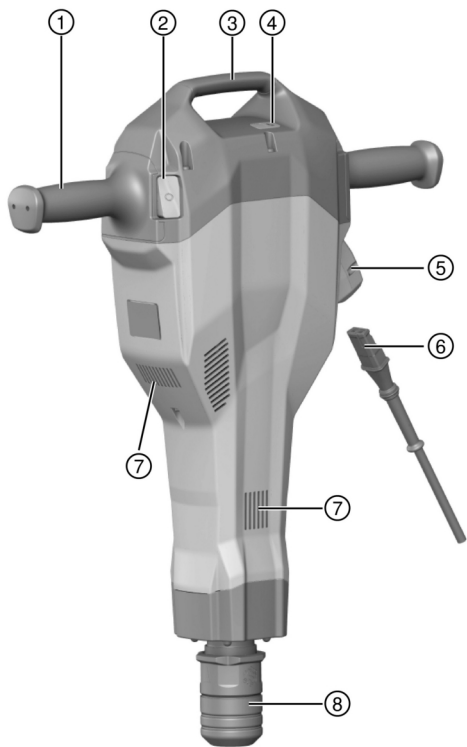

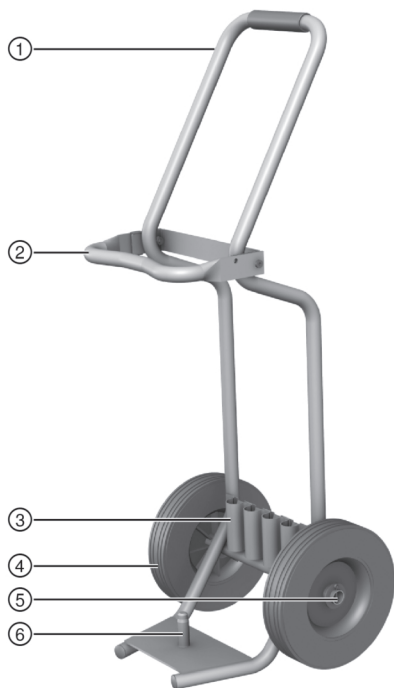

3



4

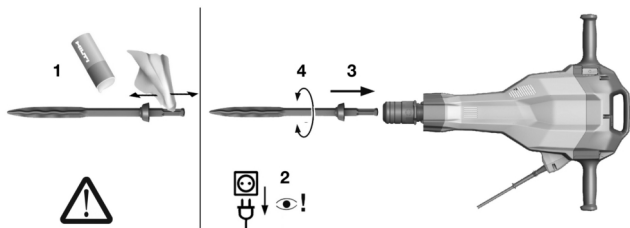

5

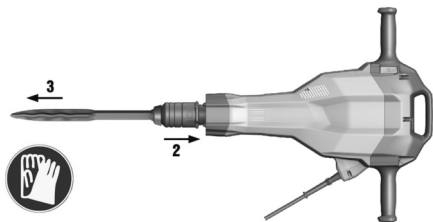

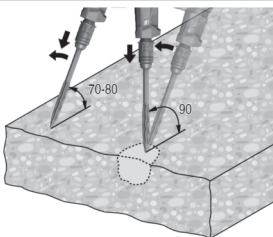
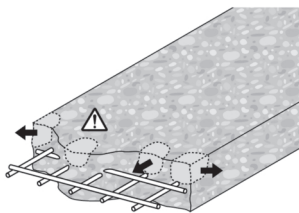
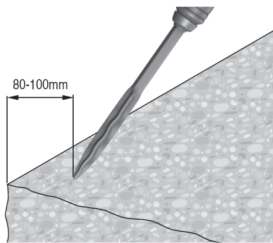

en Original operating instructions**Information about the operating instructions****About these operating instructions**

- **Warning!** Read and understand all accompanying documentation, including but not limited to instructions, safety warnings, illustrations, and specifications provided with this product. Familiarize yourself with all the instructions, safety warnings, illustrations, specifications, components, and functions of the product before use. Failure to do so may result in electric shock, fire, and/or serious injury. Save all warnings and instructions for future reference.
- **HILTI** products are designed for professional users and only trained, authorized personnel are permitted to operate, service and maintain the products. This personnel must be specifically informed about the possible hazards. The product and its ancillary equipment can present hazards if used incorrectly by untrained personnel or if used not in accordance with the intended use.
- The accompanying documentation corresponds to the current state of the art at the time of printing. Please always check for the latest version on the product's page on Hilti's website. To do this, follow the link or scan the QR code in this documentation, marked with the symbol .
- Ensure that these operating instructions are with the product when it is given to other persons.

Explanation of symbols**Warnings**

Warnings alert persons to hazards that occur when handling or using the product. The following signal words are used:

 **DANGER**

DANGER !

- ▶ Draws attention to imminent danger that will lead to serious personal injury or fatality.

 **WARNING**

WARNING !

- ▶ Draws attention to a potential threat of danger that can lead to serious injury or fatality.





 **CAUTION**

CAUTION !

- ▶ Draws attention to a potentially dangerous situation that could lead to personal injury or damage to the equipment or other property.

Symbols in the operating instructions

The following symbols are used in these operating instructions:

	Comply with the operating instructions
	Instructions for use and other useful information
	Dealing with recyclable materials
	Do not dispose of electric equipment and batteries as household waste

Symbols in illustrations

The following symbols are used in illustrations:

2	These numbers refer to the illustrations at the beginning of these operating instructions.
3	The numbers in illustrations refer to important work steps or to components important for the work steps. In the text, the corresponding numbers draw attention to these work steps or components, e.g. (3) .



11	Item reference numbers are used in the overview illustration and refer to the numbers used in the key in the product overview section.
	This symbol is intended to draw your special attention to certain points for handling the product.

Product-dependent symbols

Symbols on the product

The following symbols are used on the product:

	Protection class II (double-insulated)
	Service indicator

Safety

General power tool safety warnings

⚠ WARNING Read all safety warnings, instructions, illustrations and specifications provided with this power tool. Failure to follow all instructions listed below may result in electric shock, fire and/or serious injury.

Save all warnings and instructions for future reference.

The term "power tool" in the warnings refers to your mains-operated (corded) power tool or battery-operated (cordless) power tool.

Work area safety

- ▶ **Keep work area clean and well lit.** Cluttered or dark areas invite accidents.
- ▶ **Do not operate power tools in explosive atmospheres, such as in the presence of flammable liquids, gases or dust.** Power tools create sparks which may ignite the dust or fumes.
- ▶ **Keep children and bystanders away while operating a power tool.** Distractions can cause you to lose control.

Electrical safety

- ▶ **Power tool plugs must match the outlet. Never modify the plug in any way. Do not use any adapter plugs with earthed (grounded) power tools.** Unmodified plugs and matching outlets will reduce risk of electric shock.
- ▶ **Avoid body contact with earthed or grounded surfaces, such as pipes, radiators, ranges and refrigerators.** There is an increased risk of electric shock if your body is earthed or grounded.
- ▶ **Do not expose power tools to rain or wet conditions.** Water entering a power tool will increase the risk of electric shock.
- ▶ **Do not abuse the cord. Never use the cord for carrying, pulling or unplugging the power tool. Keep cord away from heat, oil, sharp edges or moving parts.** Damaged or entangled cords increase the risk of electric shock.
- ▶ **When operating a power tool outdoors, use an extension cord suitable for outdoor use.** Use of a cord suitable for outdoor use reduces the risk of electric shock.
- ▶ **If operating a power tool in a damp location is unavoidable, use a residual current device (RCD) protected supply.** Use of an RCD reduces the risk of electric shock.

Personal safety

- ▶ **Stay alert, watch what you are doing and use common sense when operating a power tool. Do not use a power tool while you are tired or under the influence of drugs, alcohol or medication.** A moment of inattention while operating power tools may result in serious personal injury.
- ▶ **Use personal protective equipment. Always wear eye protection.** Protective equipment such as a dust mask, non-skid safety shoes, hard hat or hearing protection used for appropriate conditions will reduce personal injuries.



- ▶ **Prevent unintentional starting.** Ensure the switch is in the off-position before connecting to power source and/or battery pack, picking up or carrying the tool. Carrying power tools with your finger on the switch or energising power tools that have the switch on invites accidents.
- ▶ **Remove any adjusting key or wrench before turning the power tool on.** A wrench or a key left attached to a rotating part of the power tool may result in personal injury.
- ▶ **Do not overreach. Keep proper footing and balance at all times.** This enables better control of the power tool in unexpected situations.
- ▶ **Dress properly. Do not wear loose clothing or jewellery. Keep your hair and clothing away from moving parts.** Loose clothes, jewellery or long hair can be caught in moving parts.
- ▶ **If devices are provided for the connection of dust extraction and collection facilities, ensure these are connected and properly used.** Use of dust collection can reduce dust-related hazards.
- ▶ **Do not let familiarity gained from frequent use of tools allow you to become complacent and ignore tool safety principles.** A careless action can cause severe injury within a fraction of a second.

Power tool use and care

- ▶ **Do not force the power tool. Use the correct power tool for your application.** The correct power tool will do the job better and safer at the rate for which it was designed.
- ▶ **Do not use the power tool if the switch does not turn it on and off.** Any power tool that cannot be controlled with the switch is dangerous and must be repaired.
- ▶ **Disconnect the plug from the power source and/or remove the battery pack, if detachable, from the power tool before making any adjustments, changing accessories, or storing power tools.** Such preventive safety measures reduce the risk of starting the power tool accidentally.
- ▶ **Store idle power tools out of the reach of children and do not allow persons unfamiliar with the power tool or these instructions to operate the power tool.** Power tools are dangerous in the hands of untrained users.
- ▶ **Maintain power tools and accessories. Check for misalignment or binding of moving parts, breakage of parts and any other condition that may affect the power tool's operation. If damaged, have the power tool repaired before use.** Many accidents are caused by poorly maintained power tools.
- ▶ **Keep cutting tools sharp and clean.** Properly maintained cutting tools with sharp cutting edges are less likely to bind and are easier to control.
- ▶ **Use the power tool, accessories and tool bits etc. in accordance with these instructions, taking into account the working conditions and the work to be performed.** Use of the power tool for operations different from those intended could result in a hazardous situation.
- ▶ **Keep handles and grasping surfaces dry, clean and free from oil and grease.** Slippery handles and grasping surfaces do not allow for safe handling and control of the tool in unexpected situations.

Service

- ▶ **Have your power tool serviced by a qualified repair person using only identical replacement parts.** This will ensure that the safety of the power tool is maintained.

Hammer safety warnings

Safety instructions for all operations

- ▶ **Wear ear protectors.** Exposure to noise can cause hearing loss.
- ▶ **Use auxiliary handle(s), if supplied with the tool.** Loss of control can cause personal injury.
- ▶ **Hold the power tool by insulated gripping surfaces, when performing an operation where the cutting accessory may contact hidden wiring or its own cord.** Cutting accessory contacting a "live" wire may make exposed metal parts of the power tool "live" and could give the operator an electric shock.



Additional safety instructions for breakers

Personal safety

- ▶ Use the product and accessories only when they are in perfect working order.
- ▶ Never tamper with or modify the product or accessories in any way.
- ▶ When chiseling into ceilings, walls and floors, always make sure that you have a safe and firm stance. A sudden break-through can affect your balance!
- ▶ Apply appropriate safety measures at the opposite side of the workpiece in work that involves breaking through. Parts breaking away could fall out and / or fall down causing injury to other persons.
- ▶ You and any other persons in the vicinity must wear suitable eye protection, a hard hat, ear protection, protective gloves and respiratory protection while the tool is in use.
- ▶ Wear protective gloves when changing the accessory tool. Touching the accessory tool can result in cuts and burns.
- ▶ Wear eye protection. Flying fragments present a risk of injury to the body and eyes.
- ▶ Dust produced by grinding, sanding, cutting and drilling can contain dangerous chemicals. Some examples are: lead or lead-based paints; brick, concrete and other masonry products, natural stone and other products containing silicates; certain types of wood, such as oak, beech and chemically treated wood; asbestos or materials that contain asbestos. Determine the exposure of the operator and bystanders by means of the hazard classification of the materials to be worked. Implement the necessary measures to restrict exposure to a safe level, for example by the use of a dust collection system or by the wearing of suitable respiratory protection. The general measures for reducing exposure include:
 - ▶ working in an area that is well ventilated,
 - ▶ avoidance of prolonged contact with dust,
 - ▶ directing dust away from the face and body,
 - ▶ wearing protective clothing and washing exposed areas of the skin with water and soap.
- ▶ Take frequent breaks and do physical exercises to improve the blood circulation in your fingers. High vibration during long periods of work can lead to disorders of the blood vessels and nervous system in the fingers, hands and wrists.

Electrical safety

- ▶ Before beginning work, check the working area for concealed electric cables or gas and water pipes. External metal parts of the product could give you an electric shock or cause an explosion if you accidentally damage an electric cable or a gas or water pipe.

Power tool use and care

- ▶ Switch the product on only after you have brought it to the working position.
- ▶ Wait until the product has come to a complete stop before you lay it down.

Description

Overview of the TE 2000-AVR 1

- | | |
|---------------------|--------------------------|
| ① Grip | ⑤ Supply cord plug |
| ② On/off switch | ⑥ Detachable supply cord |
| ③ Carrying handle | ⑦ Air vents |
| ④ Service indicator | ⑧ Chuck |

Overview of the transport trolley 2

- | | |
|--|--|
| ① Grip | ④ Wheels |
| ② Locking bar | ⑤ Wheel securing parts (washer, retaining pin) |
| ③ Holder for accessory tools (chisels) | ⑥ Power tool locating pin |



Intended use

The product described is a hand-held electric breaker. It is designed for chiseling work on concrete, masonry and asphalt. It can also be used for excavating and compacting.

The tool may be operated only when connected to a power supply providing a voltage and frequency in compliance with the information given on its rating plate.

Foreseeable misuse

- The power tool may be used only in a dry environment.
- Do not use the power tool where there is a risk of fire and explosion.
- Working with materials hazardous to health (e.g. asbestos) is not permissible.

Active Vibration Reduction

The tool is equipped with an Active Vibration Reduction (AVR) system which reduces vibration noticeably.

Service indicator

The breaker is equipped with a service indicator LED.

Status	Meaning
The service indicator lights red.	End of service interval – servicing is due. Return the product to Hilti Service for servicing in good time in order to ensure that it is always ready for use. A fault has occurred in the power tool.
The service indicator flashes red.	Protection against overheating The voltage provided by the electric supply is too high.

Items supplied

Electric breaker, detachable supply cord, operating instructions, grease. The transport trolley is available as an accessory.

You can find other system products approved for your product at your local **Hilti Center** or online at: www.hilti.group

Technical data**Breaker**

 For details of the rated voltage, current, frequency and/or input power, please refer to the power tool's country-specific type identification plate.

When powered by a generator or transformer, the generator or transformer's power output must be at least twice the rated input power shown on the rating plate of the power tool. The operating voltage of the transformer or generator must always be within +5% and -15% of the rated voltage of the power tool.

	TE 2000-AVR
Product generation	01
Weight	14.5 kg
Impact speed	30 Hz
Protection class	II



Using extension cords

WARNING

A damaged supply cord presents a hazard! Do not touch the supply cord or extension cord if damaged while working. Disconnect the supply cord plug from the power outlet.

▶ Check the appliance's supply cord at regular intervals and have it replaced by a qualified specialist if found to be damaged.

- Use only extension cords of a type approved for the application and with conductors of adequate gauge (cross section). The power tool may otherwise suffer a drop in performance and the extension cord may overheat.
- Check the extension cord for damage at regular intervals.
- Replace damaged extension cords.
- When working outdoors, use only extension cords that are approved and correspondingly marked for this application.

Recommended minimum conductor cross-section and maximum power-cord length for 120V supply voltage

Cord	AWG 16	AWG 14	AWG 12	AWG 10
Conductor cross-section	1,31 mm ²	2,08 mm ²	3,31 mm ²	5,26 mm ²
Conductor cross-section	2,58 kcmil	4,11 kcmil	6,53 kcmil	10,4 kcmil
Cord length	25 m	30 m	50 m	100 m
Cord length	75 ft	100 ft	150 ft	250 ft

Operation

Preparations at the workplace

CAUTION

Risk of injury! Inadvertent starting of the product.

▶ Unplug the supply cord before making adjustments to the power tool or before changing accessories.

Observe the safety instructions and warnings in this documentation and on the product.

Connecting the supply cord to the power tool

The releasable plug connector may be connected to the product only when it is clean and dry and when under no voltage (i.e. disconnected from the electric supply). The plug connector has a keyed fit.

1. Remove the supply cord from the cardboard box.
2. Plug the connector into the tool, pushing it in until it is heard to engage.
3. Plug the supply cord into the power outlet.

Fitting the accessory tool

1. Unplug the supply cord from the power outlet.
2. Lightly grease the connection end of the accessory tool.
 - ▶ Use only the recommended grease supplied by **Hilti**. Using the wrong grease can result in damage to the tool.
3. Push the accessory tool into the chuck as far as it will go, turning it and applying light pressure until it engages with an audible click.
4. Check that the chisel has engaged correctly by gripping and pulling it.



Removing the accessory tool

CAUTION

Risk of injury! The accessory tool may be hot and/or have sharp edges.

- ▶ Wear protective gloves when changing the accessory tool.
- ▶ Never lay down a hot accessory tool on a flammable surface.

1. Unplug the supply cord from the power outlet.
2. Pull the tool lock back as far as it will go.
3. Remove the accessory tool.

Types of work

WARNING

Risk of electric shock! Severe injury and burns can result if any attempt is made to operate the tool without an earth/ground conductor and ground fault circuit interrupter correctly connected.

- ▶ Irrespective of whether mains power or generator power is used, always make sure that an earth/ground conductor and ground fault circuit interrupter are present in the power supply and that these are correctly connected.
- ▶ Do not use the product unless these safety measures are in place and fully operational.

WARNING

A damaged supply cord presents a hazard! Do not touch the supply cord or extension cord if damaged while working. Disconnect the supply cord plug from the power outlet.

- ▶ Check the appliance's supply cord at regular intervals and have it replaced by a qualified specialist if found to be damaged.

Full approval must be obtained from the site engineer or architect prior to beginning the work.

Chiseling

1. Plug the supply cord into the power outlet.
2. Position the tip of the chisel at the desired location.
3. Press the on/off switch.

-  Working at low temperatures:
The hammering mechanism works only when the power tool has reached a minimum operating temperature. Bring the chisel into contact with the workpiece and allow the power tool to run under no load until the required temperature is reached. If necessary, repeat this procedure until the hammering mechanism begins to operate.

Switching off

1. Press the on/off switch.
2. Unplug the supply cord from the power outlet.

Working with the power tool

-  The chisel can be adjusted to 6 different positions (in 60° increments). This ensures that flat chisels and shaped chisels can always be set to the optimum working position.

- ▶ Bring the chisel into contact with the workpiece about 80 -100 mm (3 1/8" - 4") from its edge.
- ▶ When working close to reinforcing bars, always guide the tip of the chisel toward the edge of the workpiece, not toward a reinforcing bar.
- ▶ Begin with the chisel positioned at an angle of 70° to 80° to the concrete surface, with the tip of the chisel pointing toward the edge of the workpiece. Break material away by subsequently increasing the angle to approx. 90° as the chisel penetrates.
- ▶ Rotate the chisel regularly to help ensure even wear and to promote the self-sharpening process.



- ▶ If inadequate pressure is applied, the chisel will jump around uncontrollably. Application of excessive pressure will result in a loss of chiseling performance.

Optional transport trolley

Transport

The transport trolley helps to ensure that the breaker can be transported safely.

- Take care to ensure that the transport trolley stands in a steady, secure position.
- Place the power tool on the locating pin provided on the transport trolley and always secure it for transport by closing the retaining bar.
- Push the chisels into the holders provided until they engage securely.
- Take care to use only safe transport routes.
- Do not park the transport trolley on an incline.

Care and maintenance

WARNING

Electric shock hazard! Attempting care and maintenance with the supply cord connected to a power outlet can lead to severe injury and burns.

- ▶ Always unplug the supply cord before carrying out care and maintenance tasks.

Care

- Carefully remove stubborn dirt from the tool.
- Clean the air vents carefully with a dry brush.
- Use only a slightly damp cloth to clean the casing. Do not use cleaning agents containing silicone as they can attack the plastic parts.

Maintenance

WARNING

Danger of electric shock! Improper repairs to electrical components may lead to serious injuries including burns.

- ▶ Repairs to the electrical section of the tool or appliance may be carried out only by trained electrical specialists.

- Check all visible parts and controls for signs of damage at regular intervals and make sure that they all function correctly.
- Do not operate the product if signs of damage are found or if parts malfunction. Have it repaired immediately by **Hilti Service**.
- After cleaning and maintenance, fit all guards or protective devices and check that they function correctly.

 To help ensure safe and reliable operation, use only genuine Hilti spare parts and consumables. Spare parts, consumables and accessories approved by Hilti for use with the product can be found at your local **Hilti Store** or online at: **www.hilti.group**.

Troubleshooting

If the trouble you are experiencing is not listed in this table or you are unable to remedy the problem by yourself, please contact **Hilti Service**.

Troubleshooting table

Trouble or fault	Possible cause	Action to be taken
The power tool doesn't start.	Electronics initialization in progress (takes up to 4 seconds after plugging in).	▶ Switch the power tool off and on again.



Trouble or fault	Possible cause	Action to be taken
The power tool doesn't start.	Interruption in the electric supply.	▶ Plug in another electric appliance and check whether it works.
	The supply cord or plug is defective.	▶ Have the parts checked by a trained electrical specialist and replaced if necessary.
	Generator with sleep mode	▶ Apply a load to the generator by connecting a second power consumer (e.g. worklight). Then switch the power tool on and off again.
No hammering action.	The power tool is too cold.	▶ Allow the power tool to warm up to the minimum operating temperature.
	A fault has occurred in the power tool.	▶ Have the power tool repaired by Hilti Service.
The power tool doesn't start or cuts out while in operation and the indicator flashes red.	Temporary fault (e.g. overheating or overvoltage).	▶ Switch off, allow the power tool to cool down or connect it to a different electric supply.
The power tool runs but the indicator lights red continuously.	Advance warning of need for servicing.	▶ Have the power tool serviced or repaired by Hilti Service.
The power tool doesn't start or cuts out while in operation.	The extension cord is too long and/or its gauge is inadequate.	▶ Use an extension cord of an approved length and/or of adequate gauge.
	The detachable supply cord is not fitted correctly.	▶ Fit the detachable supply cord to the power tool correctly.

Disposal

Most of the materials from which **Hilti** tools and appliances are manufactured can be recycled. The materials must be correctly separated before they can be recycled. In many countries, your old tools, machines or appliances can be returned to **Hilti** for recycling. Ask **Hilti** Service or your Hilti representative for further information.

▶ Do not dispose of power tools, electronic equipment or batteries as household waste!

